

**Features**

- Voltage noise of only 1.9nV/√Hz
- Current noise of only 1.2pA/√Hz
- Bandwidth (-3dB) of 115MHz @  $A_V = +2$
- Gain-of-2 stable
- Just 4.8mA per amplifier
- 8-pin MSOP package
- $\pm 2.5V$  to  $\pm 12V$  operation

**Applications**

- ADSL receivers
- HDSLII receivers
- Ultrasound input amplifiers
- Wideband instrumentation
- Communications equipment
- AGC & PLL active filters
- Wideband sensors

**Ordering Information**

Part No.	Package	Tape & Reel	Outline #
EL2227CY	8-Pin MSOP	-	MDP0043
EL2227CY-T13	8-Pin MSOP	13"	MDP0043
EL2227CY-T7	8-Pin MSOP	7"	MDP0043
EL2227CS	8-Pin SO	-	MDP0027
EL2227CS-T13	8-Pin SO	13"	MDP0027
EL2227CS-T7	8-Pin SO	7"	MDP0027

**General Description**

The EL2227C is a dual, low-noise amplifier, ideally suited to line receiving applications in ADSL and HDSLII designs. With low noise specification of just 1.9nV/√Hz and 1.2pA/√Hz, the EL2227C is perfect for the detection of very low amplitude signals.

The EL2227C features a -3dB bandwidth of 115MHz and is gain-of-2 stable. The EL2227C also affords minimal power dissipation with a supply current of just 4.8mA per amplifier. The amplifier can be powered from supplies ranging from  $\pm 2.5V$  to  $\pm 12V$ .

The EL2227C is available in a space-saving 8-pin MSOP package as well as the industry-standard 8-pin SO. It can operate over the  $-40^{\circ}C$  to  $+85^{\circ}C$  temperature range.

**Connection Diagram**

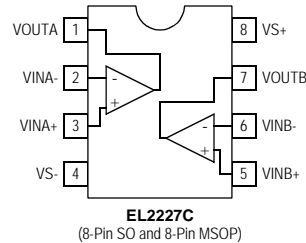

Note: All information contained in this data sheet has been carefully checked and is believed to be accurate as of the date of publication; however, this data sheet cannot be a "controlled document". Current revisions, if any, to these specifications are maintained at the factory and are available upon your request. We recommend checking the revision level before finalization of your design documentation.

# EL2227C

## Dual Very Low Noise Amplifier

### Absolute Maximum Ratings (T<sub>A</sub> = 25°C)

Values beyond absolute maximum ratings can cause the device to be prematurely damaged. Absolute maximum ratings are stress ratings only and functional device operation is not implied

Supply Voltage between V <sub>S+</sub> and V <sub>S-</sub>	28V
Input Voltage	V <sub>S-</sub> - 0.3V, V <sub>S+</sub> + 0.3V
Maximum Continuous Output Current	40mA

Maximum Die Temperature	150°C
Storage Temperature	-65°C to +150°C
Operating Temperature	-40°C to +85°C
Power Dissipation	See Curves
ESD Voltage	2kV

#### Important Note:

All parameters having Min/Max specifications are guaranteed. Typ values are for information purposes only. Unless otherwise noted, all tests are at the specified temperature and are pulsed tests, therefore: T<sub>J</sub> = T<sub>C</sub> = T<sub>A</sub>.

### Electrical Characteristics

V<sub>S+</sub> = +12V, V<sub>S-</sub> = -12V, R<sub>L</sub> = 500Ω and C<sub>L</sub> = 3pF to 0V, R<sub>F</sub> = R<sub>G</sub> = 620Ω, and T<sub>A</sub> = 25°C unless otherwise specified.

Parameter	Description	Condition	Min	Typ	Max	Unit
<b>Input Characteristics</b>						
V <sub>OS</sub>	Input Offset Voltage	V <sub>CM</sub> = 0V		-0.2	3	mV
TCV <sub>OS</sub>	Average Offset Voltage Drift	[1]		-0.6		μV/°C
I <sub>B</sub>	Input Bias Current	V <sub>CM</sub> = 0V	-9	-3.4		μA
R <sub>IN</sub>	Input Impedance			7.3		MΩ
C <sub>IN</sub>	Input Capacitance			1.6		pF
CMIR	Common-Mode Input Range		-11.8		+10.4	V
CMRR	Common-Mode Rejection Ratio	for V <sub>IN</sub> from -11.8V to 10.4V	60	94		dB
A <sub>VOL</sub>	Open-Loop Gain	-5V ≤ V <sub>OUT</sub> ≤ 5V	70	87		dB
e <sub>n</sub>	Voltage Noise	f = 100kHz		1.9		nV/√Hz
i <sub>n</sub>	Current Noise	f = 100kHz		1.2		pA/√Hz
<b>Output Characteristics</b>						
V <sub>OL</sub>	Output Swing Low	R <sub>L</sub> = 500Ω		-10.4	-10	V
		R <sub>L</sub> = 250Ω		-9.8	-9	V
V <sub>OH</sub>	Output Swing High	R <sub>L</sub> = 500Ω	10	10.4		V
		R <sub>L</sub> = 250Ω	9.5	10		V
I <sub>SC</sub>	Short Circuit Current	R <sub>L</sub> = 10Ω	140	180		mA
<b>Power Supply Performance</b>						
PSRR	Power Supply Rejection Ratio	V <sub>S</sub> is moved from ±2.25V to ±12V	65	95		dB
I <sub>S</sub>	Supply Current (Per Amplifier)	No Load		4.8	6.5	mA
V <sub>S</sub>	Operating Range		±2.5		±12	V
<b>Dynamic Performance</b>						
SR	Slew Rate <sup>[2]</sup>	±2.5V square wave, measured 25%-75%	40	50		V/μS
t <sub>S</sub>	Settling to 0.1% (A <sub>V</sub> = +2)	(A <sub>V</sub> = +2), V <sub>O</sub> = ±1V		65		ns
BW	-3dB Bandwidth	R <sub>F</sub> = 358Ω		115		MHz
HD2	2nd Harmonic Distortion	f = 1MHz, V <sub>O</sub> = 2V <sub>P-P</sub> , R <sub>L</sub> = 500Ω, R <sub>F</sub> = 358Ω		93		dBc
		f = 1MHz, V <sub>O</sub> = 2V <sub>P-P</sub> , R <sub>L</sub> = 150Ω, R <sub>F</sub> = 358Ω		83		dBc
HD3	3rd Harmonic Distortion	f = 1MHz, V <sub>O</sub> = 2V <sub>P-P</sub> , R <sub>L</sub> = 500Ω, R <sub>F</sub> = 358Ω		94		dBc
		f = 1MHz, V <sub>O</sub> = 2V <sub>P-P</sub> , R <sub>L</sub> = 150Ω, R <sub>F</sub> = 358Ω		76		dBc

# EL2227C

## Dual Very Low Noise Amplifier

EL2227C

### Electrical Characteristics

$V_{S+} = +5V$ ,  $V_{S-} = -5V$ ,  $R_L = 500\Omega$  and  $C_L = 3pF$  to  $0V$ ,  $R_F = 620\Omega$  &  $T_A = 25^\circ C$  unless otherwise specified.

Parameter	Description	Condition	Min	Typ	Max	Unit
<b>Input Characteristics</b>						
$V_{OS}$	Input Offset Voltage	$V_{CM} = 0V$		0.2	3	mV
$TCV_{OS}$	Average Offset Voltage Drift	[1]		-0.6		$\mu V/^\circ C$
$I_B$	Input Bias Current	$V_{CM} = 0V$	-9	-3.7		$\mu A$
$R_{IN}$	Input Impedance			7.3		M $\Omega$
$C_{IN}$	Input Capacitance			1.6		pF
CMIR	Common-Mode Input Range		-4.8		3.4	V
CMRR	Common-Mode Rejection Ratio	for $V_{IN}$ from -4.8V to 3.4V	60	97		dB
$A_{VOL}$	Open-Loop Gain	$-5V \leq V_{OUT} \leq 5V$	70	84		dB
$e_n$	Voltage Noise	$f = 100kHz$		1.9		$nV/\sqrt{Hz}$
$i_n$	Current Noise	$f = 100kHz$		1.2		$pA/\sqrt{Hz}$
<b>Output Characteristics</b>						
$V_{OL}$	Output Swing Low	$R_L = 500\Omega$		-3.8	-3.5	V
		$R_L = 250\Omega$		-3.7	-3.5	V
$V_{OH}$	Output Swing High	$R_L = 500\Omega$	3.5	3.7		V
		$R_L = 250\Omega$	3.5	3.6		V
$I_{SC}$	Short Circuit Current	$R_L = 10\Omega$	60	100		mA
<b>Power Supply Performance</b>						
PSRR	Power Supply Rejection Ratio	$V_S$ is moved from $\pm 2.25V$ to $\pm 12V$	65	95		dB
$I_S$	Supply Current (Per Amplifier)	No Load		4.5	5.5	mA
$V_S$	Operating Range		$\pm 2.5$		$\pm 12$	V
<b>Dynamic Performance</b>						
SR	Slew Rate <sup>[2]</sup>	$\pm 2.5V$ square wave, measured 25%-75%	35	45		V/ $\mu S$
$t_S$	Settling to 0.1% ( $A_V = +2$ )	( $A_V = +2$ ), $V_O = \pm 1V$		77		ns
BW	-3dB Bandwidth	$R_F = 358\Omega$		90		MHz
HD2	2nd Harmonic Distortion	$f = 1MHz$ , $V_O = 2V_{P-P}$ , $R_L = 500\Omega$ , $R_F = 358\Omega$		98		dBc
		$f = 1MHz$ , $V_O = 2V_{P-P}$ , $R_L = 150\Omega$ , $R_F = 358\Omega$		90		dBc
HD3	3rd Harmonic Distortion	$f = 1MHz$ , $V_O = 2V_{P-P}$ , $R_L = 500\Omega$ , $R_F = 358\Omega$		94		dBc
		$f = 1MHz$ , $V_O = 2V_{P-P}$ , $R_L = 150\Omega$ , $R_F = 358\Omega$		79		dBc

# EL2227C

## Dual Very Low Noise Amplifier

### Typical Performance Curves

Non-inverting Frequency Response for Various  $R_F$

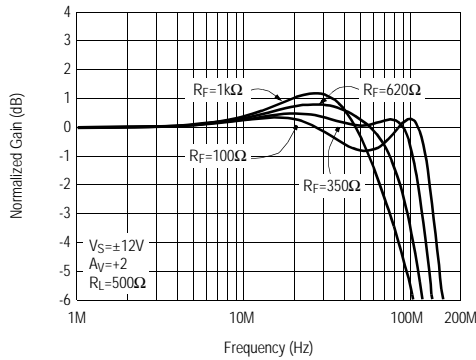

Inverting Frequency Response for Various  $R_F$

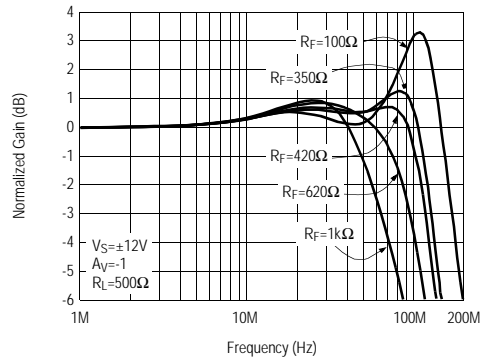

Non-inverting Frequency Response (Gain)

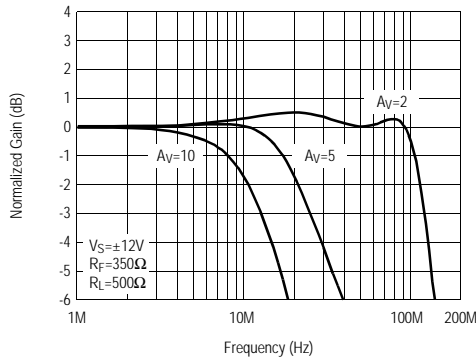

Inverting Frequency Response (Gain)

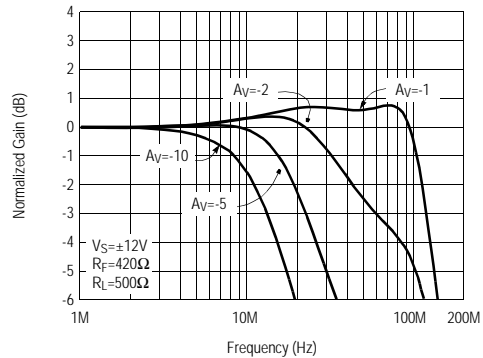

Non-inverting Frequency Response (Phase)

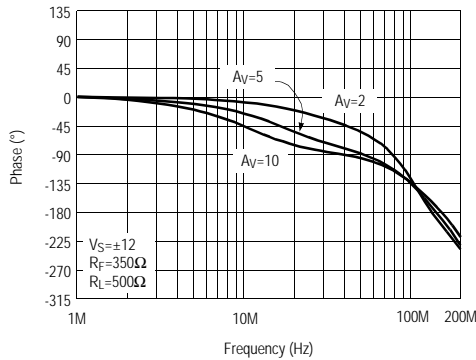

Inverting Frequency Response (Phase)

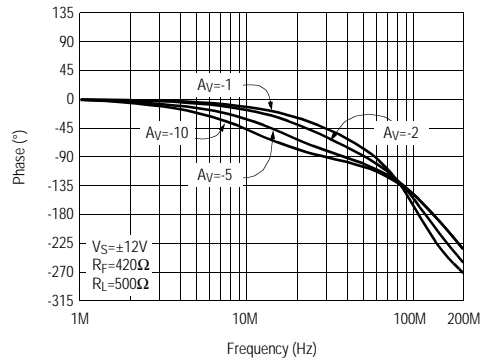

### Typical Performance Curves

**Non-inverting Frequency Response for Various Input Signal Levels**

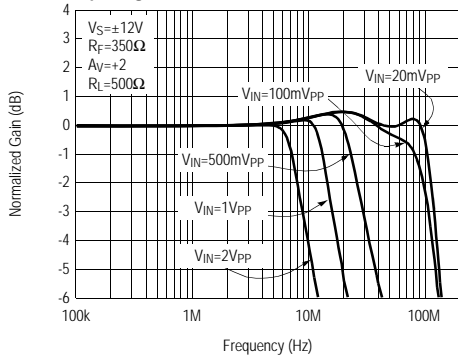

**Inverting Frequency Response for Various Input Signal Levels**

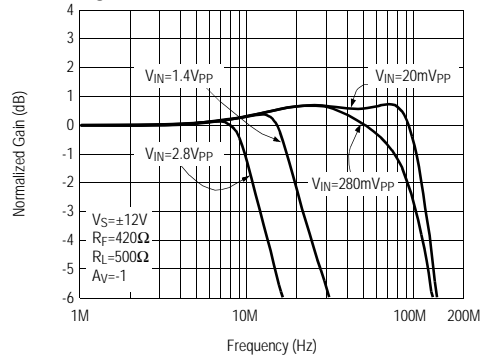

**Non-inverting Frequency Response for Various  $C_L$**

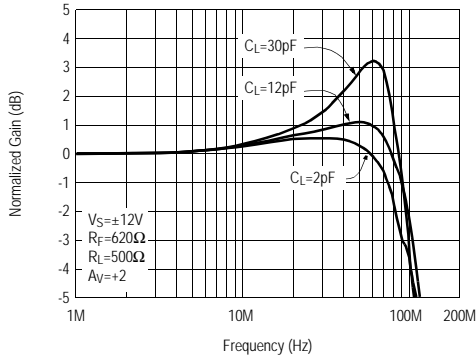

**Inverting Frequency Response for Various  $C_L$**

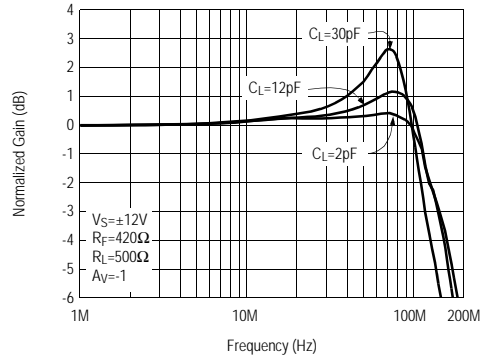

**Non-inverting Frequency Response for Various  $R_L$**

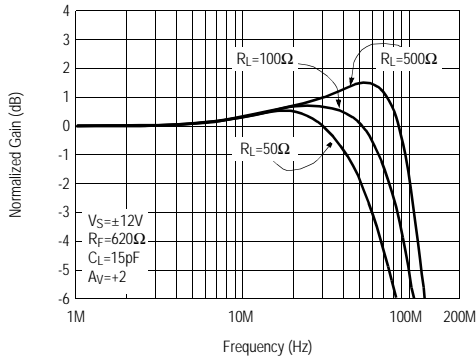

**Frequency Response for Various Output DC Levels**

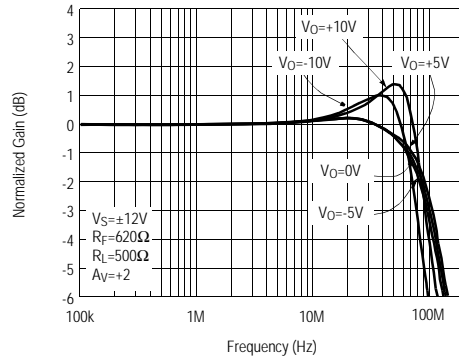

# EL2227C

## Dual Very Low Noise Amplifier

### Typical Performance Curves

3dB Bandwidth vs Supply Voltage

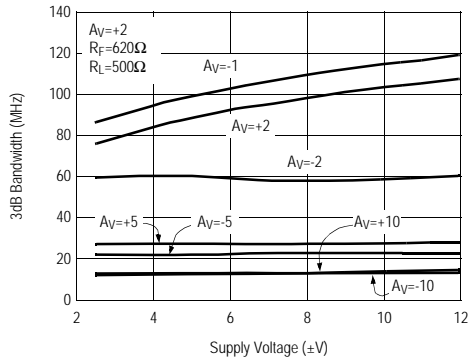

Peaking vs Supply Voltage

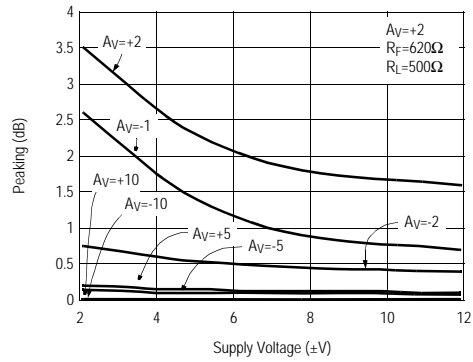

Large Signal Step Response  $V_S = \pm 12V$

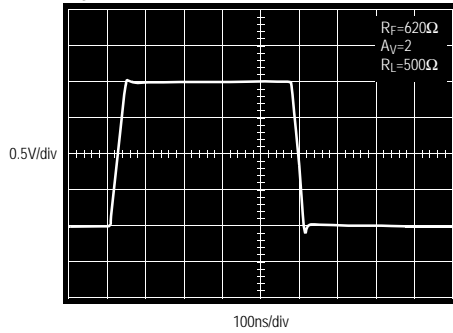

Large Signal Step Response  $V_S = \pm 2.5V$

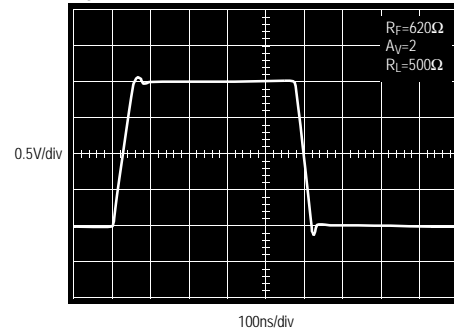

Small Signal Step Response  $V_S = \pm 12V$

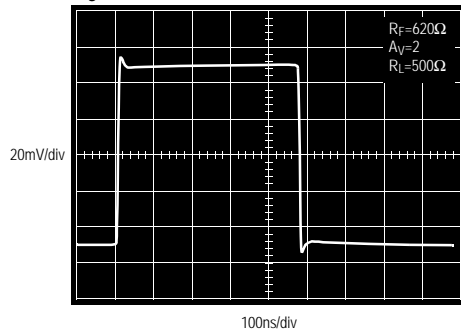

Small Signal Step Response  $V_S = \pm 2.5V$

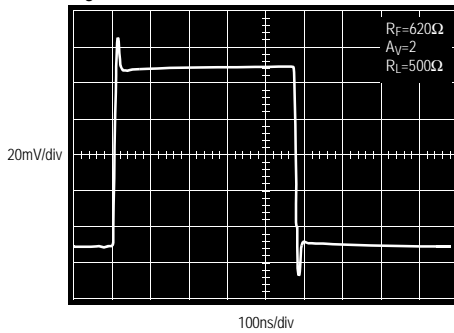

### Typical Performance Curves

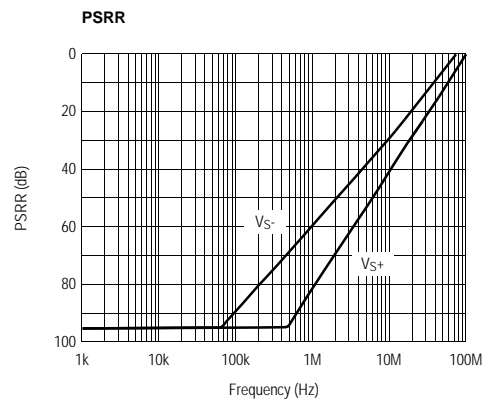
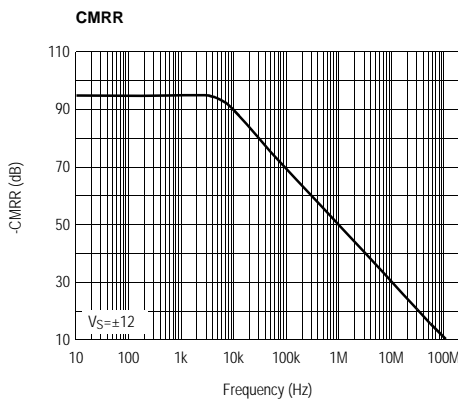
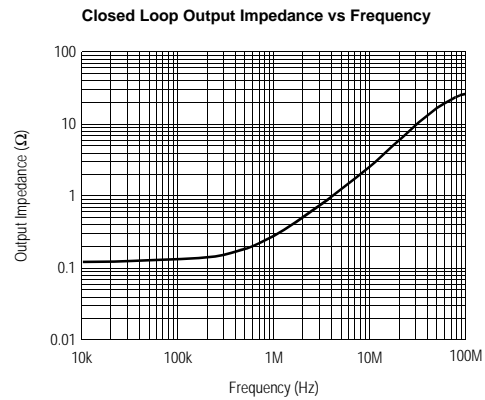
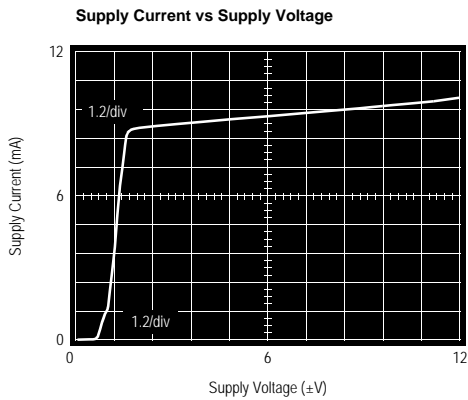
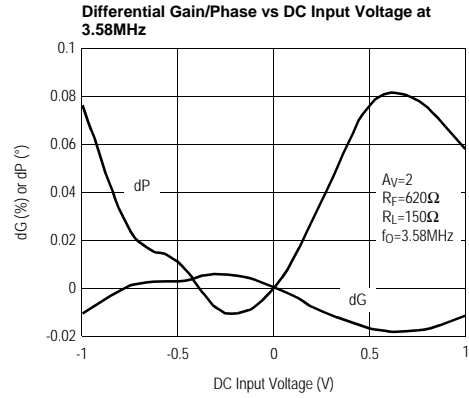
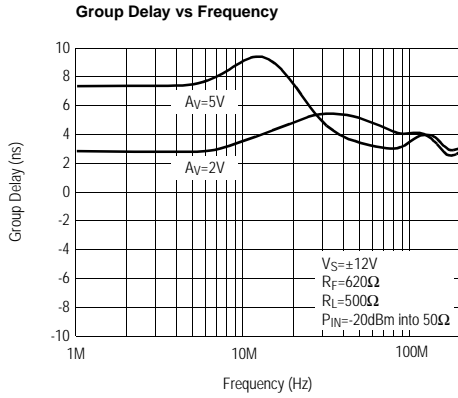

# EL2227C

## Dual Very Low Noise Amplifier

### Typical Performance Curves

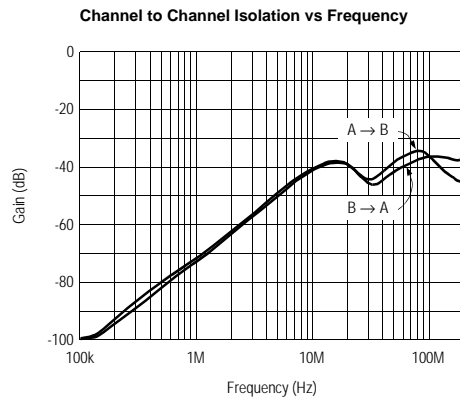
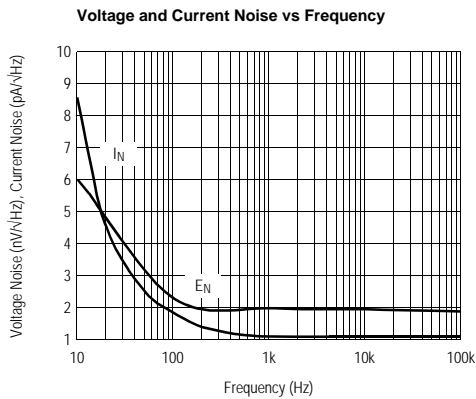
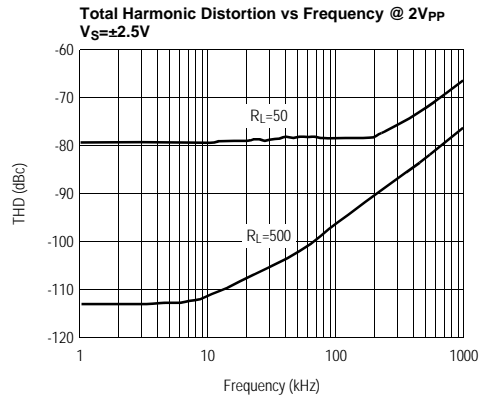
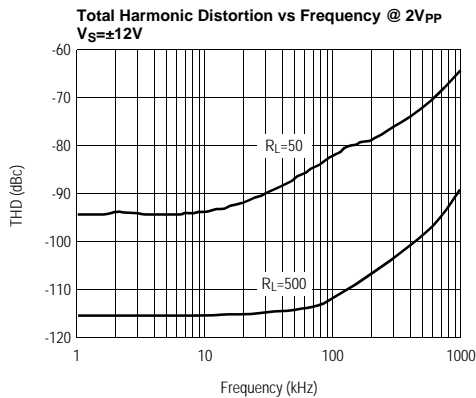
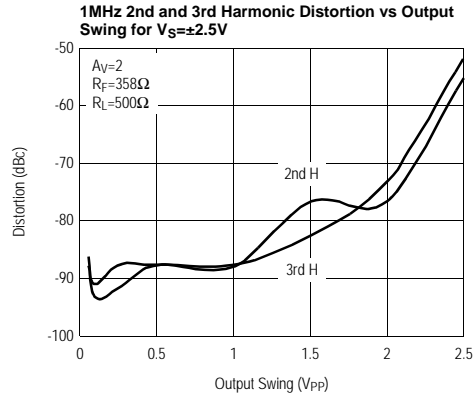
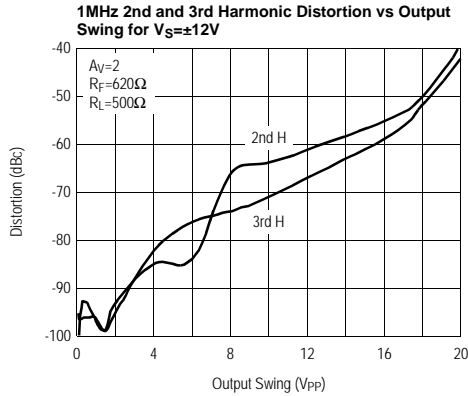



## Typical Performance Curves

**-3dB Bandwidth vs Temperature**

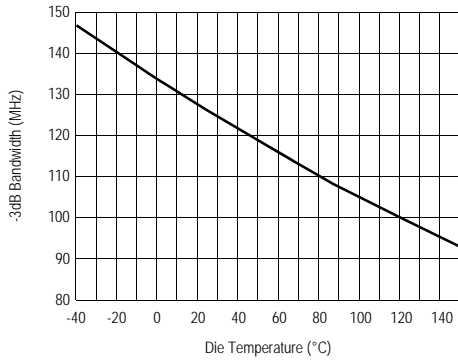

**Supply Current vs Temperature**

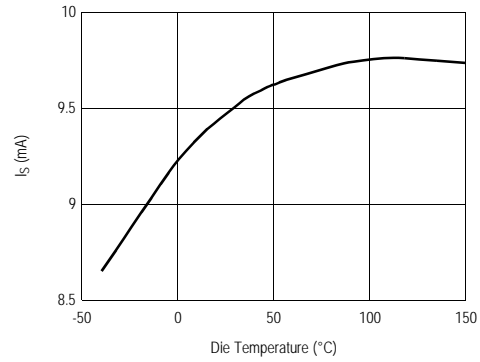

**Vos vs Temperature**

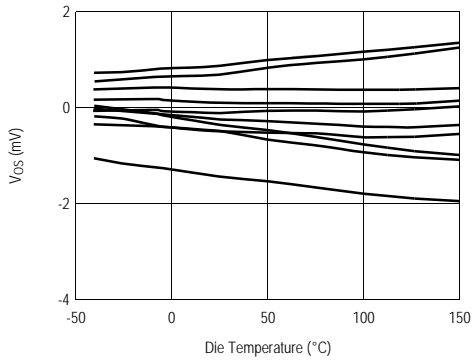

**Input Bias Current vs Temperature**

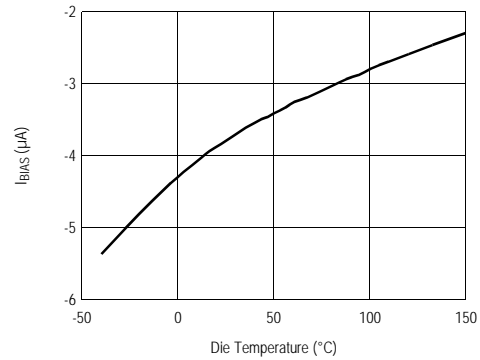

**Slew Rate vs Temperature**

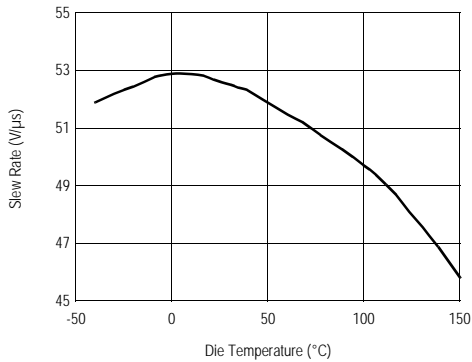

**Settling Time vs Accuracy**

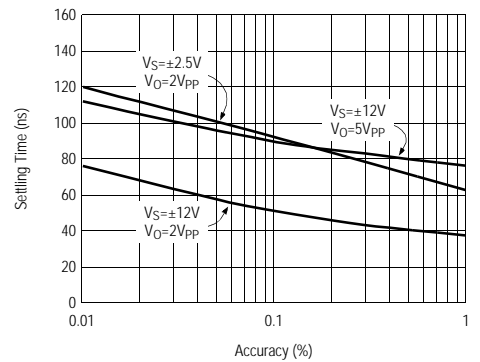

# EL2227C

Dual Very Low Noise Amplifier

## Typical Performance Curves

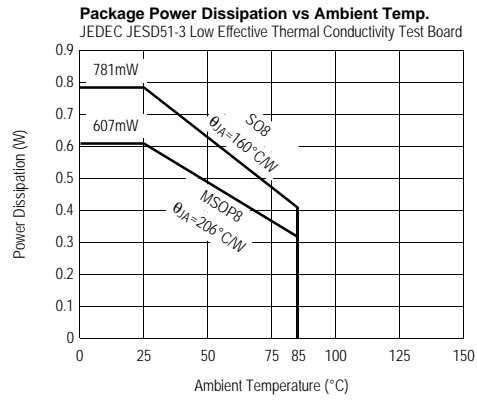

# EL2227C

Dual Very Low Noise Amplifier

EL2227C

## Pin Descriptions

EL2227CY 8-Pin MSOP	EL2227CS 8-Pin SO	Pin Name	Pin Function	Equivalent Circuit
1	1	VOUTA	Output	<p style="text-align: center;"><b>Circuit 1</b></p>
2	2	VINA-	Input	<p style="text-align: center;"><b>Circuit 2</b></p>
3	3	VINA+	Input	Reference Circuit 2
4	4	VS-	Supply	
5	5	VINB+	Input	
6	6	VINB-	Input	Reference Circuit 2
7	7	VOUTB	Output	Reference Circuit 1
8	8	VS+	Supply	

# EL2227C

Dual Very Low Noise Amplifier

## Applications Information

### Product Description

The EL2227C is a dual voltage feedback operational amplifier designed especially for DMT ADSL and other applications requiring very low voltage and current noise. It also features low distortion while drawing moderately low supply current and is built on Elantec's proprietary high-speed complementary bipolar process. The EL2227C use a classical voltage-feedback topology which allows them to be used in a variety of applications where current-feedback amplifiers are not appropriate because of restrictions placed upon the feedback element used with the amplifier. The conventional topology of the EL2227C allows, for example, a capacitor to be placed in the feedback path, making it an excellent

choice for applications such as active filters, sample-and-holds, or integrators.

### ADSL CPE Applications

The low noise EL2227C amplifier is specifically designed for the dual differential receiver amplifier function with ADSL transceiver hybrids as well as other low-noise amplifier applications. A typical ADSL CPE line interface circuit is shown in Figure 1. The EL2227C is used in receiving DMT down stream signal. With careful transceiver hybrid design and the EL2227C 1.9nV/ $\sqrt{\text{Hz}}$  voltage noise and 1.2pA/ $\sqrt{\text{Hz}}$  current noise performance, -140dBm/Hz system background noise performance can be easily achieved.

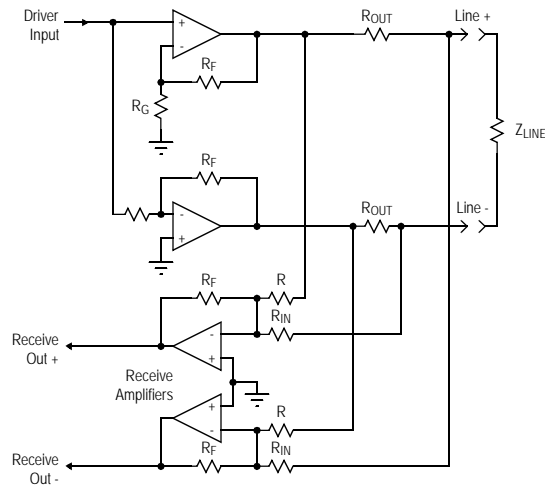
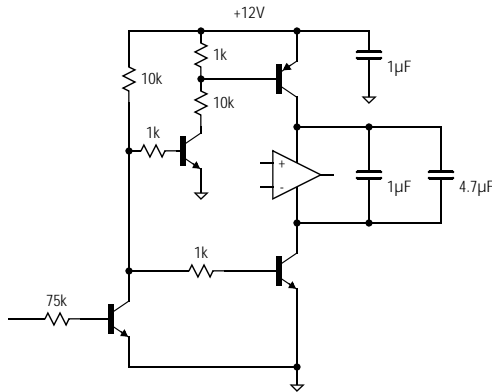

Figure 1. Typical Line Interface Connection

### Disable Function

The EL2227C is in the standard dual amplifier package without the enable/disable function. A simple way to implement the enable/disable function is depicted below. When disabled, both the positive and negative supply voltages are disconnected (see Figure 2 below.)



### Power Dissipation

With the wide power supply range and large output drive capability of the EL2227C, it is possible to exceed the 150°C maximum junction temperatures under certain load and power-supply conditions. It is therefore important to calculate the maximum junction temperature ( $T_{JMAX}$ ) for all applications to determine if power supply voltages, load conditions, or package type need to be modified for the EL2227C to remain in the safe operating area. These parameters are related as follows:

$$T_{JMAX} = T_{MAX} + (\theta_{JA} \times PD_{MAXTOTAL})$$

where:

$PD_{MAXTOTAL}$  is the sum of the maximum power dissipation of each amplifier in the package ( $PD_{MAX}$ )

$PD_{MAX}$  for each amplifier can be calculated as follows:

$$PD_{MAX} = 2 \times V_S \times I_{SMAX} + (V_S - V_{OUTMAX}) \times \frac{V_{OUTMAX}}{R_L}$$

where:

$T_{MAX}$  = Maximum Ambient Temperature

$\theta_{JA}$  = Thermal Resistance of the Package

$PD_{MAX}$  = Maximum Power Dissipation of 1 Amplifier

$V_S$  = Supply Voltage

$I_{MAX}$  = Maximum Supply Current of 1 Amplifier

$V_{OUTMAX}$  = Maximum Output Voltage Swing of the Application

$R_L$  = Load Resistance

To serve as a guide for the user, we can calculate maximum allowable supply voltages for the example of the video cable-driver below since we know that  $T_{JMAX} = 150^\circ\text{C}$ ,  $T_{MAX} = 75^\circ\text{C}$ ,  $I_{SMAX} = 9.5\text{mA}$ , and the package  $\theta_{JAS}$  are shown in Table 1. If we assume (for this example) that we are driving a back-terminated video cable, then the maximum average value (over duty-cycle) of  $V_{OUTMAX}$  is 1.4V, and  $R_L = 150\Omega$ , giving the results seen in Table 1.

**Table 1**

Part	Package	$\theta_{JA}$	Max $PD_{DISS}$ @ $T_{MAX}$	Max $V_S$
EL2227CS	SO8	160°C/W	0.406W @ 85°C	
EL2227CY	MSOP8	206°C/W	0.315W @ 85°C	

### Single-Supply Operation

The EL2227C have been designed to have a wide input and output voltage range. This design also makes the EL2227C an excellent choice for single-supply operation. Using a single positive supply, the lower input voltage range is within 200mV of ground ( $R_L = 500\Omega$ ), and the lower output voltage range is within 875mV of ground. Upper input voltage range reaches 3.6V, and output voltage range reaches 3.8V with a 5V supply and  $R_L = 500\Omega$ . This results in a 2.625V output swing on a single 5V supply. This wide output voltage range also allows single-supply operation with a supply voltage as high as 28V.

### Gain-Bandwidth Product and the -3dB Bandwidth

The EL2227C have a gain-bandwidth product of 137MHz while using only 5mA of supply current per amplifier. For gains greater than 2, their closed-loop -3dB bandwidth is approximately equal to the gain-

## ***EL2227C***

### ***Dual Very Low Noise Amplifier***

bandwidth product divided by the noise gain of the circuit. For gains less than 2, higher-order poles in the amplifiers' transfer function contribute to even higher closed loop bandwidths. For example, the EL2227C have a -3dB bandwidth of 115MHz at a gain of +2, dropping to 28MHz at a gain of +5. It is important to note that the EL2227C have been designed so that this "extra" bandwidth in low-gain applications does not come at the expense of stability. As seen in the typical performance curves, the EL2227C in a gain of +2 only exhibit 0.5dB of peaking with a 1000 $\Omega$  load.

#### **Output Drive Capability**

The EL2227C have been designed to drive low impedance loads. They can easily drive 6V<sub>pp</sub> into a 500 $\Omega$  load. This high output drive capability makes the EL2227C an ideal choice for RF, IF and video applications.

#### **Printed-Circuit Layout**

The EL2227C are well behaved, and easy to apply in most applications. However, a few simple techniques will help assure rapid, high quality results. As with any high-frequency device, good PCB layout is necessary for optimum performance. Ground-plane construction is highly recommended, as is good power supply bypassing. A 0.1 $\mu$ F ceramic capacitor is recommended for bypassing both supplies. Lead lengths should be as short as possible, and bypass capacitors should be as close to the device pins as possible. For good AC performance, parasitic capacitances should be kept to a minimum at both inputs and at the output. Resistor values should be kept under 5k $\Omega$  because of the RC time constants associated with the parasitic capacitance. Metal-film and carbon resistors are both acceptable, use of wire-wound resistors is not recommended because of their parasitic inductance. Similarly, capacitors should be low-inductance for best performance.

# ***EL2227C***

*Dual Very Low Noise Amplifier*

## **General Disclaimer**

Specifications contained in this data sheet are in effect as of the publication date shown. Elantec Semiconductor, Inc. reserves the right to make changes in the circuitry or specifications contained herein at any time without notice. Elantec Semiconductor, Inc. assumes no responsibility for the use of any circuits described herein and makes no representations that they are free from patent infringement.

***élantec***

HIGH PERFORMANCE ANALOG INTEGRATED CIRCUITS

## **Elantec Semiconductor, Inc.**

675 Trade Zone Blvd.  
Milpitas, CA 95035  
Telephone: (408) 945-1323  
(888) ELANTEC  
Fax: (408) 945-9305  
European Office: +44-118-977-6020  
Japan Technical Center: +81-45-682-5820

## **WARNING - Life Support Policy**

Elantec Semiconductor, Inc. products are not authorized for and should not be used within Life Support Systems without the specific written consent of Elantec Semiconductor, Inc. Life Support systems are equipment intended to support or sustain life and whose failure to perform when properly used in accordance with instructions provided can be reasonably expected to result in significant personal injury or death. Users contemplating application of Elantec Semiconductor, Inc. Products in Life Support Systems are requested to contact Elantec Semiconductor, Inc. factory headquarters to establish suitable terms & conditions for these applications. Elantec Semiconductor, Inc.'s warranty is limited to replacement of defective components and does not cover injury to persons or property or other consequential damages.